

IB0012

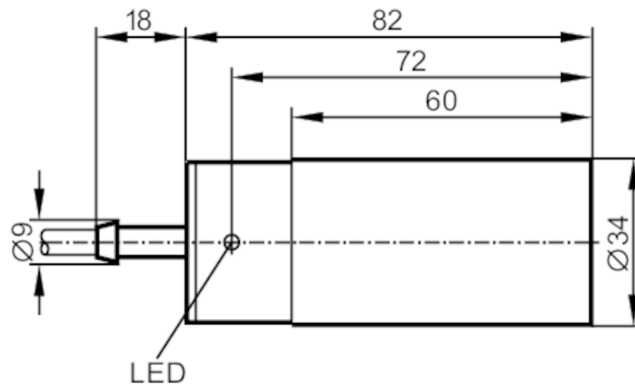

Inductive sensor

IB-2020-ABOA/10M



Product characteristics

Output function		normally open
Sensing range	[mm]	20
Housing		cylindrical
Dimensions	[mm]	Ø 34 / L = 82

Electrical data

Operating voltage	[V]	20...250 AC/DC
Protection class		II
Reverse polarity protection		no

Outputs

Output function		normally open
Max. voltage drop switching output DC	[V]	6
Max. voltage drop switching output AC	[V]	6.5
Minimum load current	[mA]	5
Max. leakage current	[mA]	2.5 (250 V AC) / 1.3 (110 V AC) / 0.8 (24 V DC)
Permanent current rating of switching output AC	[mA]	250; (350 (...50 °C))
Permanent current rating of switching output DC	[mA]	100
Short-time current rating of switching output	[mA]	2200; (20 ms / 0,5 Hz)
Switching frequency AC	[Hz]	25
Switching frequency DC	[Hz]	50
Short-circuit proof		no
Overload protection		no

Detection zone

Sensing range	[mm]	20
Real sensing range Sr	[mm]	20 ± 10 %
Operating distance	[mm]	0...16.2

IB0012



Inductive sensor

IB-2020-ABOA/10M

Accuracy / deviations		
Correction factor	steel: 1 / stainless steel: 0.7 / brass: 0.4 / aluminium: 0.4 / copper: 0.3	
Hysteresis [% of Sr]	1...15	
Switch point drift [% of Sr]	-10...10	
Operating conditions		
Ambient temperature [°C]	-25...80	
Protection	IP 67	
Tests / approvals		
EMC	EN 60947-5-2	
	EN 55011	class B
MTTF [years]	610	
Mechanical data		
Weight [g]	569	
Housing	cylindrical	
Mounting	non-flush mountable	
Dimensions [mm]	Ø 34 / L = 82	
Materials	PBT	
Displays / operating elements		
Display	switching status	1 x LED, yellow
Electrical connection		
Required protection	miniature fuse to IEC60127-2 sheet 1; ≤ 2 A; fast acting	
Accessories		
Items supplied	Mounting clamps: 1	
Remarks		
Remarks	Recommendation: Check the safe functioning of the unit after a short circuit.	
Pack quantity	1 pcs.	

Electrical connection
Cable: 10 m, PVC; 2 x 0.5 mm²

Connection

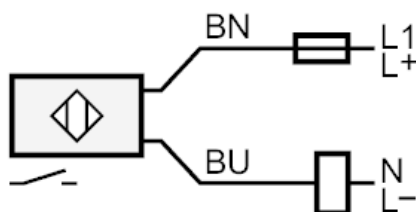

Note miniature fuse to IEC60127-2 sheet 1 ≤ 2 A fast acting
Core colours :
BN = brown
BU = blue