

IF5347

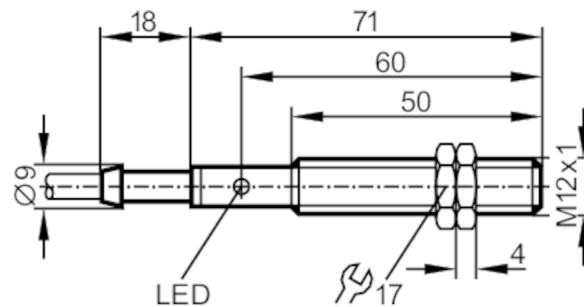

Inductive sensor

IF-3004-BPKG/10M



Product characteristics

Electrical design		PNP
Output function		normally open
Sensing range	[mm]	4
Housing		threaded type
Dimensions	[mm]	M12 x 1 / L = 71

Electrical data

Operating voltage	[V]	10...36 DC
Current consumption	[mA]	15; (24 V)
Protection class		II
Reverse polarity protection		yes

Outputs

Electrical design		PNP
Output function		normally open
Max. voltage drop switching output DC	[V]	2.5
Permanent current rating of switching output DC	[mA]	250
Switching frequency DC	[Hz]	400
Short-circuit protection		yes
Type of short-circuit protection		pulsed
Overload protection		yes

Detection zone

Sensing range	[mm]	4
Real sensing range Sr	[mm]	4 ± 10 %
Operating distance	[mm]	0...3.25

Accuracy / deviations

Correction factor		steel: 1 / stainless steel: 0.7 / brass: 0.4 / aluminium: 0.3 / copper: 0.2
Hysteresis	[% of Sr]	1...15
Switch point drift	[% of Sr]	-10...10

IF5347



Inductive sensor

IF-3004-BPKG/10M

Operating conditions		
Ambient temperature	[°C]	-25...80
Protection		IP 67
Tests / approvals		
EMC	EN 60947-5-2	
	EN 55011	class B
MTTF	[years]	945
Mechanical data		
Weight	[g]	371.7
Housing		threaded type
Mounting		non-flush mountable
Dimensions	[mm]	M12 x 1 / L = 71
Thread designation		M12 x 1
Materials		PBT
Displays / operating elements		
Display	switching status	1 x LED, yellow
Accessories		
Items supplied		lock nuts: 2
Remarks		
Pack quantity		1 pcs.

Electrical connection
Cable: 10 m, PVC; 3 x 0.34 mm²

Connection

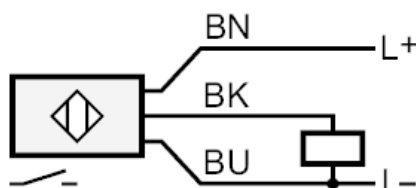

Core colours :
BN = brown
BU = blue
BK = black